

# MOSFET

Metall Oxide Semiconductor Field Effect Transistor

## CoolMOS E6

650V CoolMOS™ E6 Power Transistor  
IPx65R600E6

## Data Sheet

Rev. 2.2, 2016-08-04

## 1 Description

CoolMOS™ is a revolutionary technology for high voltage power MOSFETs, designed according to the superjunction (SJ) principle and pioneered by Infineon Technologies. CoolMOS™ DE series combines the experience of the leading SJ MOSFET supplier with high class innovation. The resulting devices provide all benefits of a fast switching SJ MOSFET while not sacrificing ease of use. Extremely low switching and conduction losses make switching applications even more efficient, more compact, lighter, and cooler.

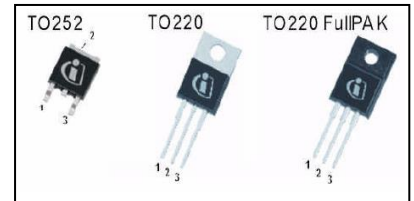

### Features

- Extremely low losses due to very low  $F O M R_{dson} * Q_g$  and  $E_{oss}$
- Very high commutation ruggedness
- Easy to use/drive
- JEDEC<sup>1)</sup> qualified, Pb-free plating, available in Halogen free mold compound<sup>2)</sup>

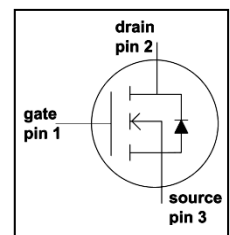

### Applications

PFC stages, hard switching PWM stages and resonant switching PWM stages e.g. PC Silverbox, Adapter, LCD & PDP TV, Lightning, Server, Telecom and UPS.

*Please note: For MOSFET paralleling the use of ferrite beads on the gate or separate totem poles is generally recommended.*



**Table 1 Key Performance Parameters**

Parameter	Value	Unit
$V_{DS} @ T_{j, max}$	700	V
$R_{DS(on), max}$	0.6	$\Omega$
$Q_G, typ$	23	nC
$I_D, pulse$	18	A
$E_{oss} @ 400V$	2	$\mu J$
Body diode di/dt	500	A/ $\mu s$

Type / Ordering Code	Package	Marking	Related links
IPD65R600E6	PG-TO252	65E6600	<a href="#">IFX CoolMOS Webpage</a> <a href="#">IFX Design tools</a>
IPP65R600E6	PG-TO220		
IPA65R600E6	PG-TO220 FullIPAK		

1) J-STD20 and JESD22

2) For PG-TO252: non-Halogen free (OPN: IPD65R600E6BT); Halogen free (OPN: IPD65R600E6AT)

## Table of Contents

1	Description.....	2
2	Maximum ratings.....	4
3	Thermal characteristics.....	5
4	Electrical characteristics.....	5
5	Electrical characteristics diagrams.....	8
6	Test circuits.....	13
7	Package outlines.....	14
8	Revision History.....	17

## 2 Maximum ratings

At  $T_j = 25\text{ °C}$ , unless otherwise specified.

**Table 2 Maximum ratings**

Parameter	Symbol	Values			Unit	Note/Test Condition
		Min.	Typ.	Max.		
Continuous drain current <sup>1)</sup>	$I_D$	–	–	7.3	A	$T_C = 25\text{ °C}$
		–	–	4.6		$T_C = 100\text{ °C}$
Pulsed drain current <sup>2)</sup>	$I_{D, pulse}$	–	–	18		$T_C = 25\text{ °C}$
Averlanche energy, single pulse	$E_{AS}$	–	–	142	mJ	$I_D = 1.3\text{ A}; V_{DD} = 50\text{ V};$ $T_C = 25\text{ °C}$ (see Table 11)
Averlanche energy, repetitive	$E_{AR}$	–	–	0.21		$I_D = 1.3\text{ A}, V_{DD} = 50\text{ V}$
Avalanche current, repetitive	$I_{AR}$	–	–	1.3	A	
MOSFET dv/dt ruggedness	$dv/dt$	–	–	50	V/ns	$V_{DS} = 0 \dots 480\text{ V}$
Gate source voltage	$V_{GS}$	-20	–	20	V	static
		-30		30		AC ( $f > 1\text{ Hz}$ )
Power dissipation for Non FullPAK	$P_{tot}$	–	–	63	W	$T_C = 25\text{ °C}$
Power dissipation for FullPAK	$P_{tot}$	–	–	28	W	$T_C = 25\text{ °C}$
Operating and storage temperature	$T_j, T_{stg}$	-55	–	150	°C	
Mounting torque TO-220		–	–	60	Ncm	M3 and M3.5 screws
Mounting torque TO-220 FullPAK		–	–	50		M2.5 Screws
Continous diode forward current	$I_S$	–	–	6.3	A	$T_C = 25\text{ °C}$
Diode pulse current <sup>2)</sup>	$I_{S, pulsed}$	–	–	18	A	$T_C = 25\text{ °C}$
Reverse diode dv/dt <sup>3)</sup>	$dv/dt$	–	–	15	V/ns	$V_{DS} = 0 \dots 480\text{ V}, I_{SD} \leq I_D,$
Maximum diode commutation speed <sup>3)</sup>	$di/dt$			500	A/ $\mu\text{s}$	$T_C = 125\text{ °C}$ (see table 22)

1) Limited by  $T_{j, max}$ . Maximum duty cycle  $D=0.75$

2) Pulse width  $t_p$  limited by  $T_{j, max}$

3) Identical low side and high side switch with identical  $R_\theta$

### 3 Thermal characteristics

**Table 3 Thermal characteristics TO-220 (IPP65R600E6)**

Parameter	Symbol	Values			Unit	Note/Test Condition
		Min.	Typ.	Max.		
Thermal resistance, junction-case	$R_{thJC}$	–	–	2.0	°C/W	leaded
Thermal resistance, junction-ambient	$R_{thJA}$	–	–	62		
Soldering temperature, wavesoldering only allowed at leads	$T_{sold}$	–	–	260	°C	1.6mm (0.063 in.) from case for 10 s

**Table 4 Thermal characteristics TO-220 FullPAK (IPA65R600E6)**

Parameter	Symbol	Values			Unit	Note/Test Condition
		Min.	Typ.	Max.		
Thermal resistance, junction-case	$R_{thJC}$	–	–	4.5	°C/W	leaded
Thermal resistance, junction-ambient	$R_{thJA}$	–	–	80		
Soldering temperature, wavesoldering only allowed at leads	$T_{sold}$	–	–	260	°C	1.6mm (0.063 in.) from case for 10 s

**Table 5 Thermal characteristics TO-252 (IPD65R600E6)**

Parameter	Symbol	Values			Unit	Note/Test Condition
		Min.	Typ.	Max.		
Thermal resistance, junction-case	$R_{thJC}$	–	–	2.0	°C/W	SMD version, device on PCB, minimal footprint
Thermal resistance, junction-ambient	$R_{thJA}$	–	–	62		
			35			
Soldering temperature, wave- & reflowsoldering only allowed	$T_{sold}$	–	–	260	°C	Reflow MSL1

1) Device on 40mm\*40mm\*1.5 epoxy PCB FR4 with 6cm<sup>2</sup> (one layer, 70µm thick) copper area for drain connection. PCB is vertical without air stream cooling.

## 4 Electrical characteristics

Electrical characteristics, at  $T_j=25^\circ\text{C}$ , unless otherwise specified

**Table 6 Static characteristics**

Parameter	Symbol	Values			Unit	Note/Test Condition
		Min.	Typ.	Max.		
Drain-source Breakdown voltage	$V_{(BR)DSS}$	650	–	–	V	$V_{GS}=0V, I_D=1.0mA$
Gate threshold voltage	$V_{GS(th)}$	2.5	3	3.5		$V_{DS}=V_{GS}, I_D=0.21mA$
Zero gate Voltage drain current	$I_{DSS}$	–	–	1	$\mu\text{A}$	$V_{DS}=600V, V_{GS}=0V,$ $T_j=25^\circ\text{C}$
		–	10	–		$V_{DS}=600V, V_{GS}=0V,$ $T_j=150^\circ\text{C}$
Gate- source leakage current	$I_{GSS}$	–	–	100	nA	$V_{GS}=20V, V_{DS}=0V$
Drain- source on- state resistance	$R_{DS(on)}$	–	0.54	0.6	$\Omega$	$V_{GS}=10V, I_D=2.1A,$ $T_j=25^\circ\text{C}$
		–	1.40	–		$V_{GS}=10V, I_D=2.1A,$ $T_j=150^\circ\text{C}$
Gate resistance	$R_G$	–	10.5	–	$\Omega$	$f=1\text{MHz}, \text{open drain}$

**Table7 Dynamic characteristics**

Parameter	Symbol	Values			Unit	Note/Test Condition	
		Min.	Typ.	Max.			
Input capacitance	$C_{iss}$	–	440	–	pF	$V_{GS}=0V, V_{DS}=100V,$ $f=1\text{MHz}$	
Output capacitance	$C_{oss}$	–	30	–			
Effective output capacitance, energy related <sup>1)</sup>	$C_{o(er)}$	–	21	–			$V_{GS}=0V,$ $V_{DS}=0\dots480V$
Effective output capacitance, time related <sup>2)</sup>	$C_{o(tr)}$	–	88	–			$I_D=const$ $V_{GS}=0V, V_{DS}=0\dots480V$
Turn- on delay time	$t_{d(on)}$	–	10	–	ns	$V_{DD}=400V$ $V_{GS}=13V, I_D=3.2A,$ $R_G=6.8\Omega$ (see table 20)	
Rise time	$t_r$	–	8	–			
Turn- off delay time	$t_{d(off)}$	–	64	–			
Fall time	$t_f$	–	11	–			

1)  $C_{o(er)}$  is a fixed capacitance that gives the same stored energy as  $C_{oss}$  while  $V_{DS}$  is rising from 0 to 80%  $V_{(BR)DSS}$

2)  $C_{o(tr)}$  is a fixed capacitance that gives the same charging time as  $C_{oss}$  while  $V_{DS}$  is rising from 0 to 80%  $V_{(BR)DSS}$

**Table 8 Gate charge characteristics**

Parameter	Symbol	Values			Unit	Note/Test Condition
		Min.	Typ.	Max.		
Gate to source charge	$Q_{GS}$	–	2.75	–	nC	$V_{DD}=480V, I_D=3.2A,$ $V_{GS}=0$ to 10 V
Gate to drain charge	$Q_{GD}$	–	12	–		
Gate charge, total	$Q_G$	–	23	–		
Gate plateau voltage	$V_{plateau}$	–	5.5	–	V	

**Table 8 Reverse diode characteristics**

Parameter	Symbol	Values			Unit	Note/Test Condition
		Min.	Typ.	Max.		
Diode forward voltage	$V_{SD}$	–	0.9	–	V	$V_{GS}=0V, I_F=3.2A,$ $T_J=25^\circ C$
Reverse recovery time	$t_{rr}$	–	270	–	ns	$V_R=400V, I_F=3.2A,$ $diF/dt=100A/\mu s$ (see table 22)
Reverse recovery charge	$Q_{rr}$	–	2.0	–	nC	
Peak reverse recovery current	$I_{rm}$	–	13	–	A	

## 5 Electrical characteristics diagrams

Table 10

Power dissipation Non FullPAK	Power dissipation FULLPAK
$P_{tot} = f(T_C)$	$P_{tot} = f(T_C)$

Table 11

Max. transient thermal impedance Non FullPAK	Max. transient thermal impedance Non FullPAK
$Z_{(thJC)} = f(t_p)$ ; parameter: $D = t_p / T$	$Z_{(thJC)} = f(t_p)$ ; parameter: $D = t_p / T$



Table 12

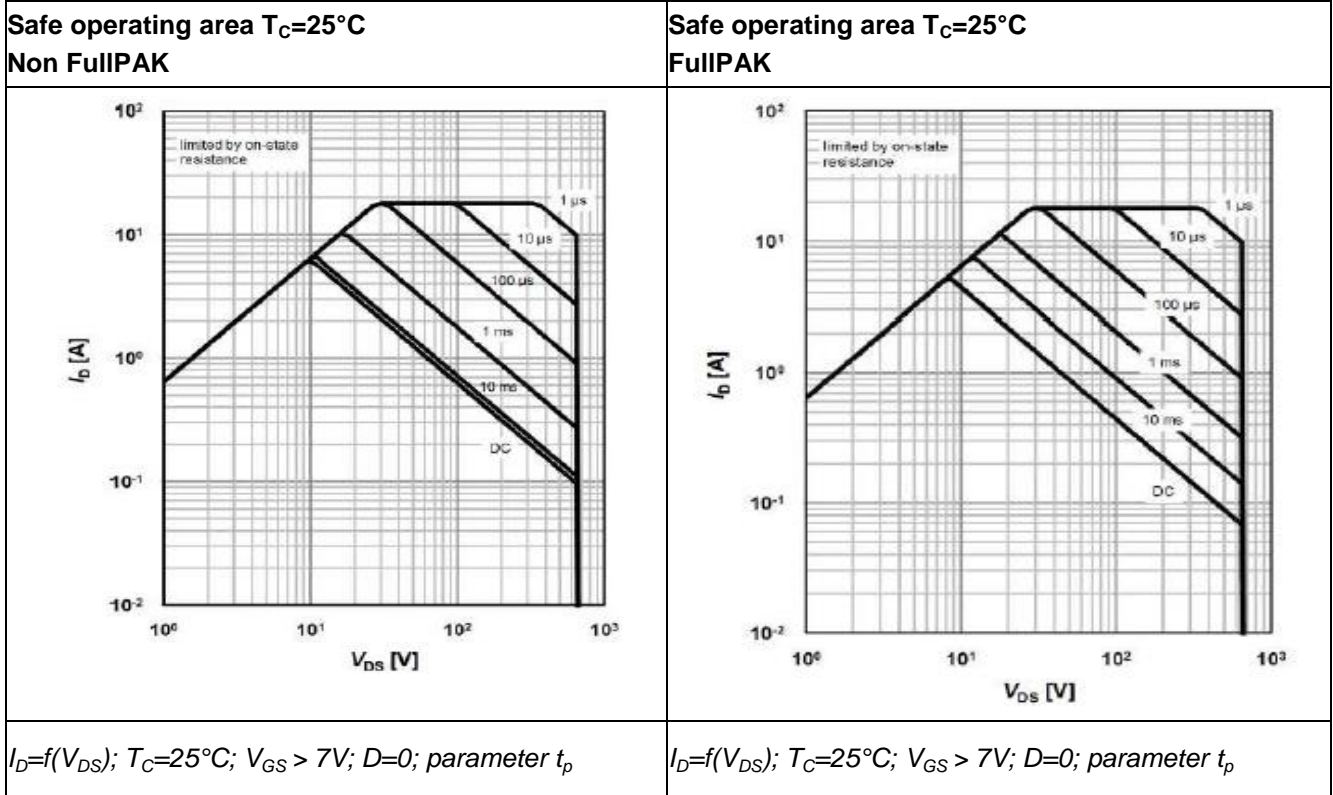

Table 13

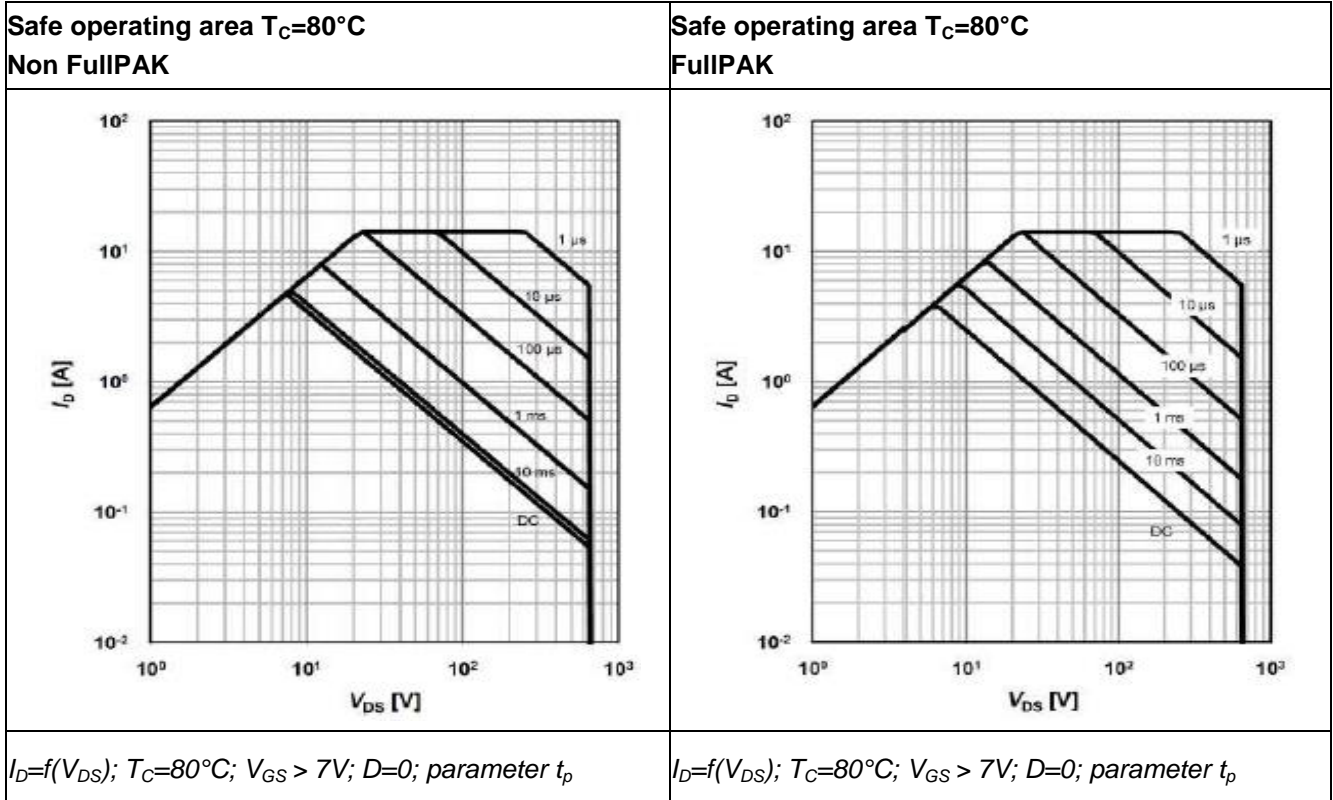

Table 14

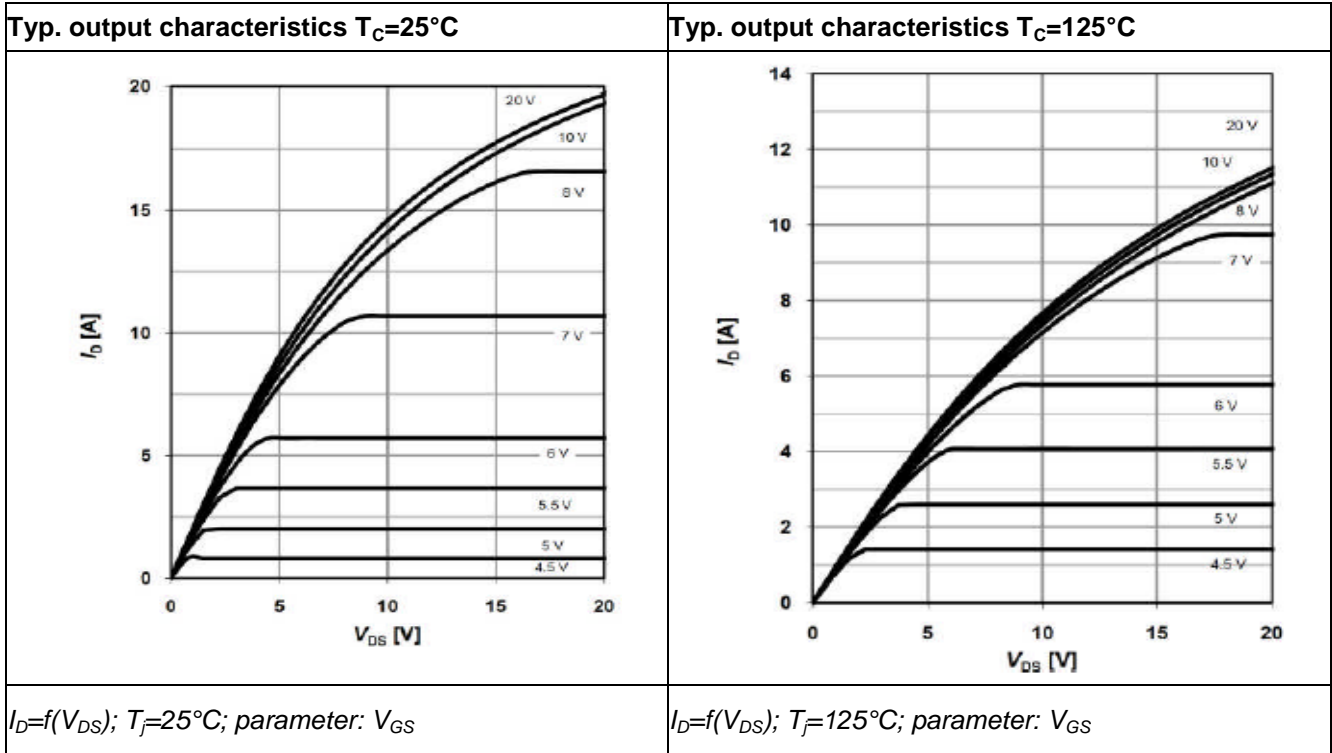

Table 15

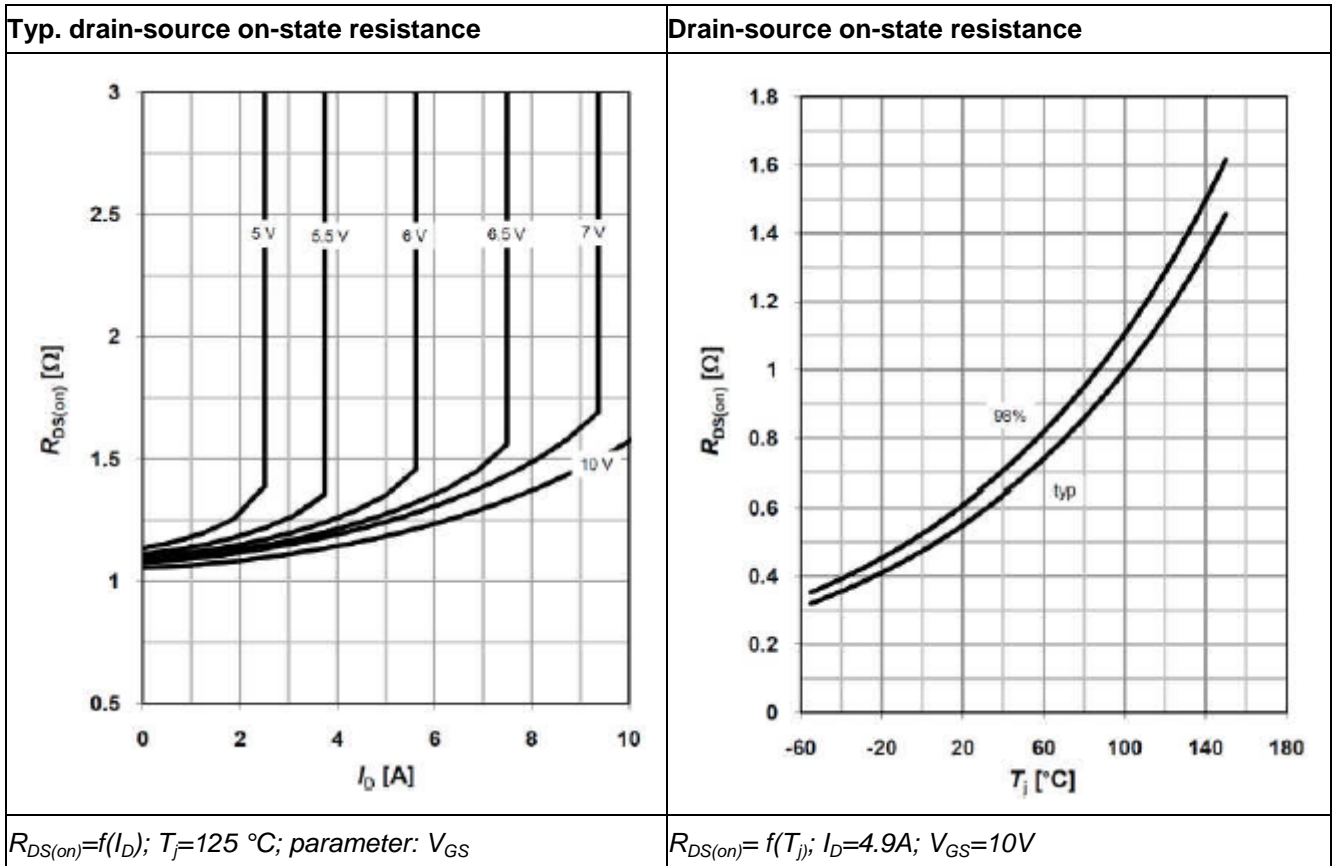

Table 16

Typ. transfer characteristics	Typ. gate charge
$I_D = f(V_{GS}); V_{DS} = 20V$	$V_{GS} = f(Q_{gate}), I_D = 4.9 A \text{ pulsed}$

Table 17

Avalanche energy	Drain-source breakdown voltage
$E_{AS} = f(T_j); I_D = 1.8 A; V_{DD} = 50 V$	$V_{BR(DSS)} = f(T_j); I_D = 1.0 mA$

Table 18

Typ. capacitances	Typ. $C_{OSS}$ stored energy
$C=f(V_{DS}); V_{GS}=0\text{ V}; f=1\text{ MHz}$	$E_{OSS}=f(V_{DS})$

Table 19

Forward characteristics of reverse diode
$I_F=f(V_{SD}); \text{parameter: } T_j$

## 6 Test circuits

Table 20 Switching times test circuit and waveform for inductive load

Switching times test circuit for inductive load	Switching time waveform

Table 11

Unclamped inductive load test circuit	Unclamped inductive waveform

Table 22

Test circuit for diode characteristics	Diode recovery waveform

7 Package outlines

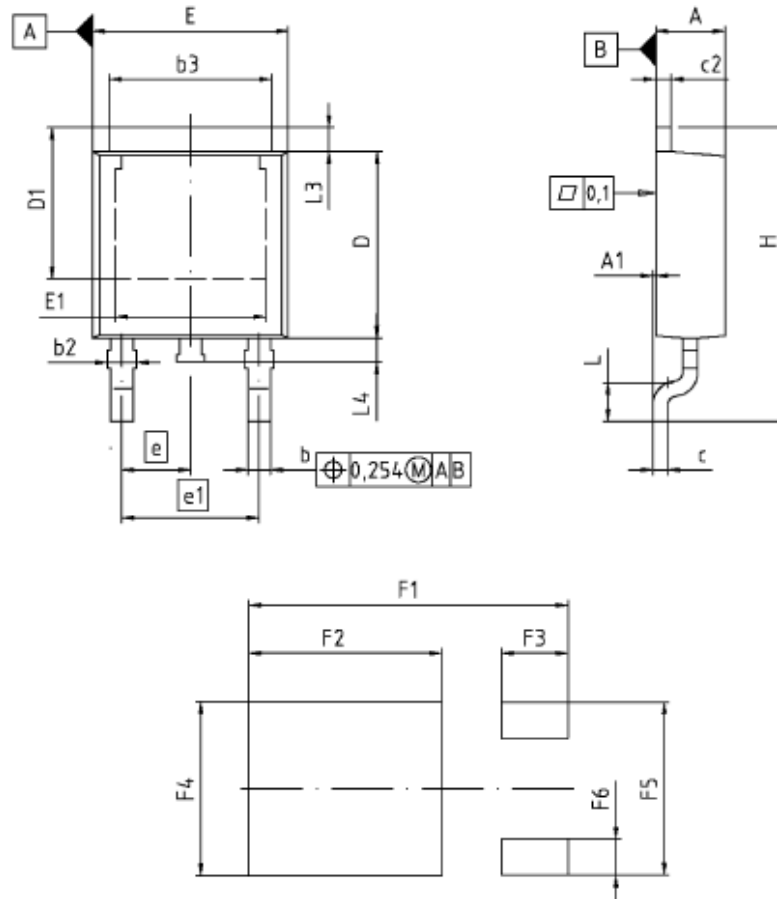

DIM	MILLIMETERS		INCHES	
	MIN	MAX	MIN	MAX
A	2.16	2.41	0.085	0.095
A1	0.00	0.15	0.000	0.008
b	0.84	0.89	0.025	0.035
b2	0.65	1.15	0.026	0.045
b3	5.00	5.50	0.197	0.217
c	0.46	0.80	0.018	0.024
c2	0.46	0.98	0.018	0.039
D	5.97	6.22	0.235	0.245
D1	5.02	5.84	0.198	0.230
E	6.40	6.73	0.252	0.265
E1	4.70	5.21	0.185	0.205
e	2.29		0.090	
e1	4.57		0.180	
N	3		3	
H	9.40	10.48	0.370	0.413
L	1.18	1.70	0.046	0.067
L3	0.90	1.25	0.035	0.049
L4	0.51	1.00	0.020	0.039
F1	10.50	10.70	0.413	0.421
F2	6.30	6.50	0.248	0.256
F3	2.10	2.30	0.083	0.091
F4	5.70	5.90	0.224	0.232
F5	5.66	5.66	0.223	0.231
F6	1.10	1.30	0.043	0.051

DOCUMENT NO.  
Z8B0003328

SCALE

EUROPEAN PROJECTION

ISSUE DATE  
19-10-2007

REVISION  
03

Figure 1 Outlines TO-252,, dimensions in mm/inches

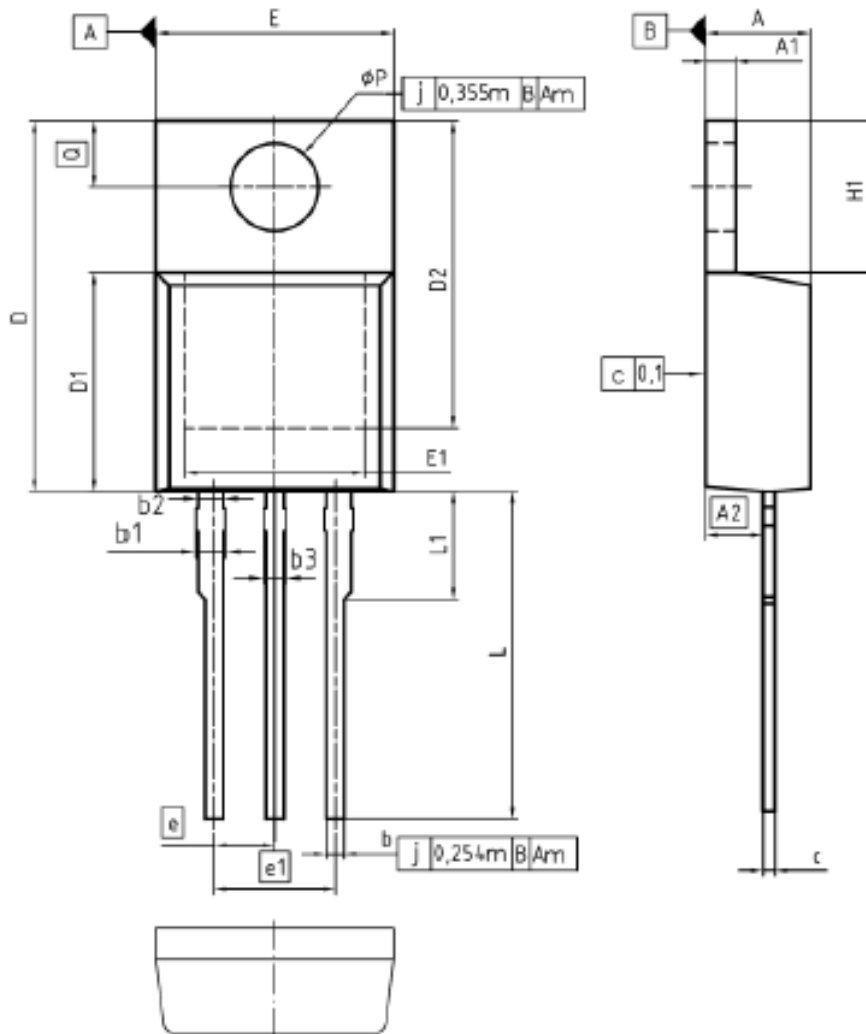

DIM	MILLIMETERS		INCHES	
	MIN	MAX	MIN	MAX
A	4.30	4.57	0.169	0.180
A1	1.17	1.40	0.046	0.055
A2	2.15	2.72	0.085	0.107
b	0.65	0.86	0.026	0.034
b1	0.95	1.40	0.037	0.055
b2	0.95	1.15	0.037	0.045
b3	0.65	1.15	0.026	0.045
c	0.33	0.60	0.013	0.024
D	14.81	15.95	0.583	0.628
D1	8.51	9.45	0.335	0.372
D2	12.19	13.10	0.480	0.516
E	9.70	10.36	0.382	0.408
E1	6.50	8.00	0.256	0.339
e	2.54		0.100	
e1	5.08		0.200	
N	3		3	
H1	5.90	6.90	0.232	0.272
L	13.00	14.00	0.512	0.551
L1	-	4.80	-	0.189
phi P	3.80	3.89	0.142	0.153
Q	2.80	3.00	0.102	0.118

DOCUMENT NO.  
Z8B00003318

SCALE  
0 2.5 5mm

EUROPEAN PROJECTION

ISSUE DATE  
23-06-2007

REVISION  
05

Figure 2 Outlines TO220, dimensions in mm/inches

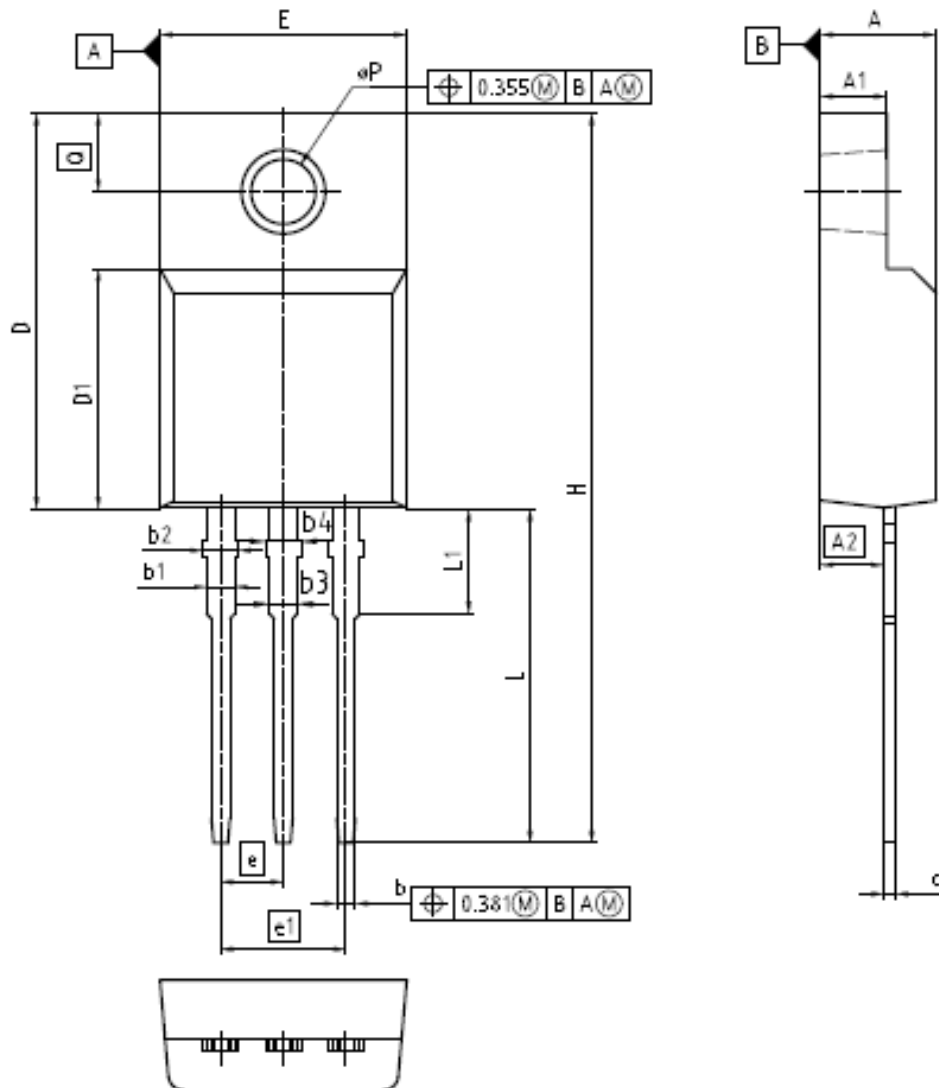

DIMENSIONS DO NOT INCLUDE MOLD FLASH, PROTRUSIONS OR GATE BURRS.

DIM	MILLIMETERS		INCHES	
	MIN	MAX	MIN	MAX
A	4.50	4.90	0.177	0.193
A1	2.34	2.85	0.092	0.112
A2	2.42	2.86	0.095	0.113
b	0.65	0.90	0.026	0.035
b1	0.95	1.38	0.037	0.054
b2	0.95	1.51	0.037	0.059
b3	0.65	1.38	0.026	0.054
b4	0.65	1.51	0.026	0.059
ø	0.40	0.63	0.016	0.025
D	15.67	16.15	0.617	0.636
D1	8.97	9.83	0.353	0.387
E	10.00	10.65	0.394	0.419
e	2.54 (BSC)		0.100 (BSC)	
e1	5.08		0.200	
N	3		3	
H	28.70	29.75	1.130	1.171
L	12.78	13.75	0.503	0.541
L1	2.83	3.45	0.111	0.136
øP	2.95	3.38	0.116	0.133
ø	3.15	3.50	0.124	0.138

DOCUMENT NO.  
Z8B00003319

SCALE

EUROPEAN PROJECTION

ISSUE DATE  
24-10-2014

REVISION  
05

Figure 3 Outlines TO220 FullPAK, dimensions in mm/inches



## 8 Revision History

Revision History: 2016-08-04, Rev. 2.2

Previous Revision:

Revision	Subjects (major changes since last version)
2.0	Release of final data sheet
2.1	Update halogen free mold compound status of PG-TO252 package
2.2	Update PG-TO220 FullPAK drawing on page 16

### We Listen to Your Comments

Any information within this document that you feel is wrong, unclear or missing at all?  
Your feedback will help us to continuously improve the quality of this document.

Please send your proposal (including a reference to this document) to: [erratum@infineon.com](mailto:erratum@infineon.com)



Edition 2011-12-09

Published by

Infineon Technologies AG

81726 Munich, Germany

© 2011 Infineon Technologies AG

All Rights Reserved.

### Legal Disclaimer

The information given in this document shall in no event be regarded as a guarantee of conditions or characteristics. With respect to any examples or hints given herein, any typical values stated herein and/or any information regarding the application of the device, Infineon Technologies hereby disclaims any and all warranties and liabilities of any kind, including without limitation, warranties of non-infringement of intellectual property rights of any third party.

### Information

For further information on technology, delivery terms and conditions and prices, please contact the nearest Infineon Technologies Office ([www.infineon.com](http://www.infineon.com)).

### Warnings

Due to technical requirements, components may contain dangerous substances. For information on the types in question, please contact the nearest Infineon Technologies Office.

The Infineon Technologies component described in this Data Sheet may be used in life-support devices or systems and/or automotive, aviation and aerospace applications or systems only with the express written approval of Infineon Technologies, if a failure of such components can reasonably be expected to cause the failure of that life-support, automotive, aviation and aerospace device or system or to affect the safety or effectiveness of that device or system. Life support devices or systems are intended to be implanted in the human body or to support and/or maintain and sustain and/or protect human life. If they fail, it is reasonable to assume that the health of the user or other persons may be endangered.

[www.infineon.com](http://www.infineon.com)

Published by Infineon Technologies AG